



SYSTEM USER GUIDE

XR SERIES CONTROL PANEL

HOW TO HANDLE AN ALARM

Enter your user code or present your credential to the keypad if it has a built-in proximity reader. You will see:

IS THIS A FALSE ALARM? YES NO or CANCEL VERIFY

Real Alarm

Press **NO** or **VERIFY** to notify to the emergency monitoring station.
Your system will remain armed.

False Alarm

Press **YES** or **CANCEL** to cancel the alarm.
Your system will disarm.

TABLE OF CONTENTS

Get to Know Your System	1	Outputs On/Off.....	18
Use Your Keypad	3	Favorites	18
LCD Keypad.....	3	Z-Wave Setup	20
Graphic Touchscreen Keypad.....	4	Wi-Fi Setup.....	22
Type in Your Keypad.....	7	Zone Status.....	23
Standard Keyboard.....	7	Bypass Zones.....	24
Number Pad.....	8	Zone Monitor.....	24
Know Your System Type.....	9	System Status	25
Area (A)	9	System Test.....	25
All/Perimeter (All Perim)	9	User Profiles	26
Home/Sleep/Away (with Guest).....	10	User Codes.....	30
Arm Your System.....	11	Ambush Code	31
Area (A)	11	Schedules	32
All/Perimeter (All Perim)	11	Time	35
Home/Sleep/Away (H S A).....	11	Display Events	35
More Arming Options.....	12	Service Request	36
Disarm Your System.....	14	Fire Drill.....	36
How to Handle an Alarm	14	Appendix	38
Disarm Your System.....	14	User Authority Descriptions.....	38
User Menu	15	Add a User Code	40
Alarm Silence	15	Change a User Code	41
Sensor Reset	16	Common Keypad Displays.....	42
Lockdown.....	16	Glossary	44
Door Lock/Unlock.....	17	Notes	45
Door Access	17		
Armed Areas	17		

GET TO KNOW YOUR SYSTEM

Your system may not include all of the equipment and functions found in this guide.

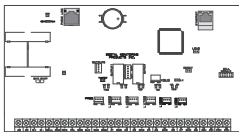

Control Panel

The control panel acts as your system's brain. It communicates with the keypad and all the other system devices throughout the building.

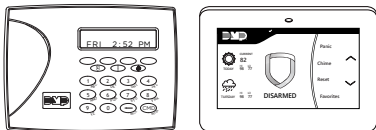

Keypad

The keypad allows you to control your system from one place. You can use it to arm and disarm your system, add user codes, verify alarms, and many other functions.



Prox Key

A prox key is an impact resistant credential that fits on a standard key ring. It allows for codeless arming, disarming, and door access when it is presented to a reader.

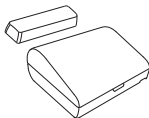

Sensor

Sensors are small devices that monitor motion, temperature, flooding, breaking glass, and know when windows and doors have been opened.



Key Fob Remote

Depending on how your key fob remote is set up, it provides an easy way to arm and disarm your system or send a panic alarm.

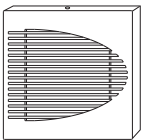

Siren

The siren emits sound when your system goes into alarm.

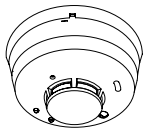

Smoke and Carbon Monoxide (CO) Detector

These detectors notify you when smoke or carbon monoxide is present. Some detectors have an integrated synchronized sounder. If they are installed in groups, they will all sound simultaneously.

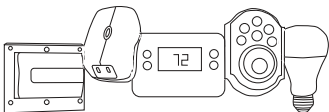

Z-Wave™

Z-Wave devices allow you to control the lights, small appliances, garage doors, thermostats, and locks from the keypad, Virtual Keypad™ App, and VirtualKeypad.com™.



Virtual Keypad App and VirtualKeypad.com

The Virtual Keypad App and VirtualKeypad.com allow you to control and monitor your system on the go. The app is available for Apple® and Android™ devices.

USE YOUR KEYPAD

LCD Keypad

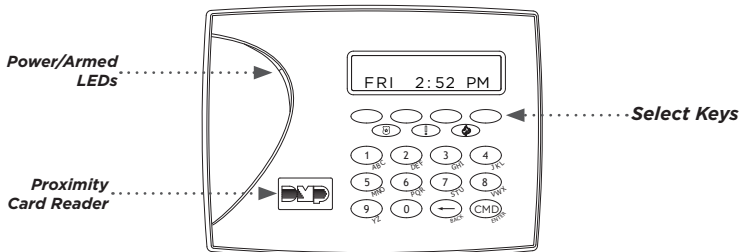

Proximity Card Reader

The keypad may have a built-in proximity card reader that allows you to arm or disarm your system when you present a credential.

Power and Armed LEDs

The AC Power and Armed LEDs indicate your system's power and armed status.

Select Keys

Use the select keys to type and navigate in the keypad. See *Type in Your Keypad* for more information.

7/0 Panic Feature (Hardwired systems only)

Press and hold the **7** and **0** keys at the same time to send a fire, emergency, or panic report to the emergency monitoring station.

Graphic Touchscreen Keypad

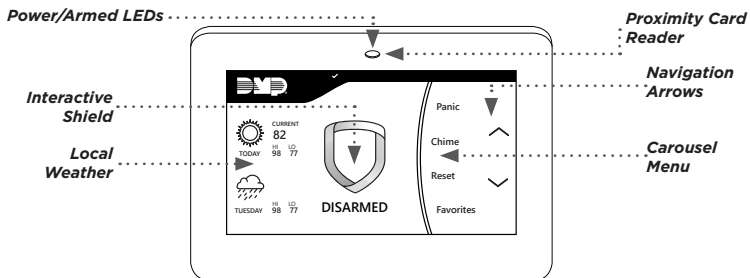

Options

On the LCD keypad, press and hold the **CMD** and back arrow keys at the same time to access the Options Menu. On the Graphic Touchscreen Keypad, press **Options** in the carousel menu. From here, you can adjust the keypad brightness, tone, and volume.

If the keypad brightness is set to **0**, the keypad and LED will turn off when not in use. Brightness level **1** turns off the keypad when not in use but the LED remains on.

Interactive Shield

On the Graphic Touchscreen Keypad, press the shield to display your arming options. Disarm your system by pressing the shield and entering your user code.

Carousel Menu

On the Graphic Touchscreen Keypad, use the navigation arrows or press and drag to scroll through the carousel menu options.

Carousel Menu Options for Graphic Touchscreen Keypads

Panic

Press **Police**, **Emergency**, or **Fire** to send a panic report to the emergency monitoring station.

Chime

Press **Chime** to turn the chime feature on and off. If chime is on, the keypad will sound an alert and display a notification when external doors and windows (with sensors installed) are opened.

Reset

Press **Reset** to reset fire and panic sensors after they have triggered an alarm.

Favorites

Favorites displays a list of your Z-Wave favorites. Press a Favorite to activate it.

Easy Exit

When your system is armed, press **Easy Exit** to allow you to leave through an exit door without triggering the alarm or needing to disarm and re-arm your system.

Options

Press **Options** to display the Setting Options screen. From here, you can adjust the keypad screen brightness, tone, and volume. You can also choose what you want to display in the carousel menu.

Keypad

Press **Keypad** to display a standard DMP keypad. Use this option to access the User Menu. See *Type In Your Keypad* for more information.

Carousel Menu Options for Graphic Touchscreen Keypads

User Codes	Press User Codes to add, edit, or delete user codes in your system.
Schedules	Press Schedules to add, edit, or delete schedules. You can also use it to assign schedules to outputs and favorites, as well as auto-arming and auto-disarming.
Events	Events allows you to view up to 12,000 past events that occurred on your system over the last 45 days.
Thermostats	Press Thermostats to display the Z-Wave thermostats screen. From here, you can adjust the temperature or select ON , OFF , HEAT , COOL , or FAN .
Doors	Press Doors to lock or unlock Z-Wave locks. You can also open and close Z-Wave-equipped garage doors.
Lights	Press Lights to turn ON , turn OFF , or DIM Z-Wave lights.

TYPE IN YOUR KEYPAD

Both keypads offer the number pad, but only the Graphic Touchscreen Keypad offers the standard keyboard. Use the table and the keypad select areas that are shown in the graphics below to enter characters using the number pad. Follow the directions to enter characters using the standard keyboard.

Standard Keyboard

- Press **ABC** to access uppercase letters.
- Press **abc** to access lowercase letters.
- Press **!@#** to access symbols.
- Press **123** to access the number pad.

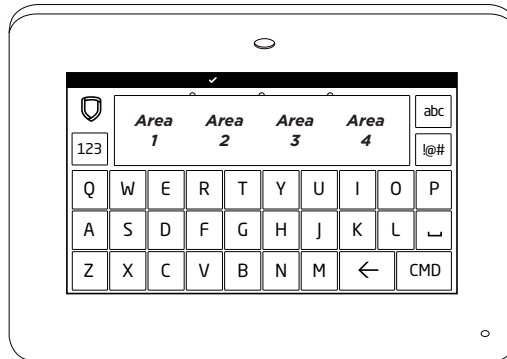

Standard Keyboard and Select Areas

Number Pad

1. Choose a character from the table.
2. Identify the **Number** the character correlates with and press that character on the number pad.
3. Identify the **Select Key or Area** for that character and press that select key or area on the keypad. To access the lowercase letter, press that select key or area again.
4. When the desired character displays on the keypad, return to Step 1 to enter another character or press **CMD** if finished.

NUMBER	SELECT AREA			
	1	2	3	4
1	A	B	C	([{
2	D	E	F)] }
3	G	H	I	! ^ ~
4	J	K	L	? "
5	M	N	O	/ \ `
6	P	Q	R	& \$
7	S	T	U	@ %
8	V	W	X	, =
9	Y	Z	Space :	_ ;
0	- +	. '	* <	# >

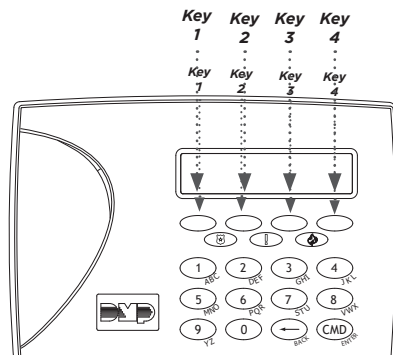

**Number Pad and
Select Keys**

KNOW YOUR SYSTEM TYPE

Your system operates in one of the following ways: Area, All/Perimeter, Home/Sleep/Away, or Home/Sleep/Away with Guest. Regardless of which system type you have, much of the operation is similar. The best way to identify your system type, is to arm it.

On an LCD Keypad, press **CMD** until **ARM DISARM** display, then press the select key under **ARM**. The arming options display. Identify your system type, then press the back arrow to exit the arming screen.

On a Graphic Touchscreen Keypad, touch the interactive shield and the arming options display. Identify your system type, then press the shield at the top of the keypad to exit the arming screen.

Area (A)

Your system can have up to 32 separate areas for an XR550 control panel and up to 8 separate areas for an XR150 control panel. Each area can do the following:

- It can have a custom name.
- It can arm or disarm independently of other areas.
- It can limit access to users.

All/Perimeter (All Perim)

The building is divided into 2 main areas:

All

- Arms both the perimeter and the interior of the building.
- Use when you're leaving the building and no one remains inside.

Perimeter

- Arms just the perimeter of the building.
- Use when you're staying inside the building.

Home/Sleep/Away (with Guest)

The building is divided into 2 or 3 areas: perimeter, interior, and bedrooms. For guest systems, you can have up to 2 guest areas.

Home

- Arms the perimeter of the building.
- Use when you're staying in the building.

Sleep

- Arms the perimeter and a portion of the interior.
- Use to leave the bedroom areas of the building unarmed.

Away

- Arms the perimeter, interior, and bedrooms.
- Is used when you're leaving the building and no one remains inside.

ARM YOUR SYSTEM

Area (A)

1. Press and release the shield on a Graphic Touchscreen Keypad to open the arming options screen or press **CMD** on an LCD Keypad until **ARM DISARM** displays.
2. Select **ARM**. The keypad displays **ALL? NO YES**.
3. To arm all areas, select **YES**. To arm selected areas, select **NO**. The keypad displays each area you have access to. Select **YES** to arm the areas and **NO** to leave the area disarmed.

All/Perimeter (All Perim)

1. Enter your user code and the keypad displays **PERIM ALL**.
2. Select **ALL** to arm all areas. The keypad displays **ALL SYSTEM ON**. Select **PERIM** to arm only the perimeter. The keypad displays **PERIMETER ON**.

Home/Sleep/Away (H S A)

1. Enter your user code and the keypad displays **H S A**.
2. Select **HOME** if you're staying inside the building, leaving the interior disarmed and arming the exterior. Select **SLEEP** to leave the bedroom areas disarmed, arming the interior and exterior areas. Select **AWAY** if no one will remain inside the building.

More Arming Options

Instantly Arm Your System

1. Press and release the shield on a Graphic Touchscreen Keypad to open the arming options screen or press **CMD** on an LCD keypad until **ARM DISARM** displays.
2. Select **INSTANT**. This overrides the entry and exit delay, instantly arming your system.

Use the Keypad Shortcut Keys

The LCD Keypad and the Graphic Touchscreen Keypad provides one-button shortcut keys. Press the key for two seconds until a tone sounds.

KEY	OPERATION
	Arm Away for Home/Sleep/Away systems
1	Arm Away for Home/Sleep/Away with Guest systems Arm All for All/Perimeter systems
2	Fire and Panic Sensor Reset on all systems
3	Arm Home for Home/Sleep/Away systems Arm Home for Home/Sleep/Away with Guest systems
5	Monitor (Chime) on all systems
6	Arm Perimeter for All/Perimeter systems
7	Arm Sleep for Home/Sleep/Away systems Arm Sleep for Home/Sleep/Away with Guest systems
8	Easy Exit for Home/Sleep/Away systems

Bypass Zones

If a problem exists on any zone, the zone name and problem display, followed by **OK BYPASS STOP**.

- Press **OK** to force arm the zone. The zone will re-arm when it's restored.
- Press **BYPASS** to ignore the zone before arming. Panic, emergency, fire, flood detector, and temperature sensor zones cannot be bypassed.
- Press **STOP** to stop your system from arming. This allows you to correct the zone, return to the keypad, and restart the arming process.

Extend Schedules

When a schedule is active, you can extend the schedule to a later time. When arming your system, the keypad displays **LATE** or **CLOSING TIME!**.

1. Press any select key or area. The keypad displays **ENTER CODE:-**.
2. Enter your user code and press **CMD** or present your credential to a card reader.
3. The keypad displays **2HR 4HR 6HR 8HR**. Select the number of hours to extend the schedule.

DISARM YOUR SYSTEM

How to Handle an Alarm

Enter your user code or present your credential to the keypad if it has a built-in proximity reader.
You will see:

IS THIS A FALSE ALARM? YES NO or CANCEL VERIFY

Real Alarm

Press **NO** or **VERIFY** to notify the emergency monitoring station. Your system will remain armed.

False Alarm

Press **YES** or **CANCEL** to cancel the alarm. Your system will disarm.

Disarm Your System

1. Press the shield on the Graphic Touchscreen Keypad and enter your user code to disarm your system or press **CMD** on the LCD Keypad until **ARM DISARM** displays.
2. Select **DISARM**. The keypad displays **ALL? NO YES**.
3. Select **YES** to disarm all areas. Select **NO** to disarm individual areas and select **YES** to disarm the area or **NO** to leave the area armed.

USER MENU

You have access to many functions in the User Menu that can be accessed from the keypad. Enter your user code and the functions you have access to, display. The User Menu allows you to create user profiles, add, change, and delete user codes, create favorites with your Z-Wave devices, and more.

Below are the User Menu functions and their processes as you will see them on the keypad. Before using a function, you will need to access the User Menu. See *Access the User Menu* below.

Access the User Menu

1. Press **CMD** until **MENU? NO YES** displays.
2. Select **YES**.
3. Enter your user code and press **CMD**.

Alarm Silence

Alarm silence turns off your bells and sirens when your system is in alarm. It does not stop a report from being sent to the emergency monitoring station.

Silence an Alarm:

1. Access the User Menu.
2. At **ALARM SILENCE?**, press any select key or area to silence the bells or sirens.

Sensor Reset

Sensor Reset resets panic and fire sensors after they have been tripped. They must be reset before they can detect any additional alarm conditions.

Reset All Sensors

1. Access the User Menu.
2. Press **CMD** until **SENSOR RESET?** displays.
3. Press a top row select key or area. The keypad displays **SENSORS OFF** followed by **SENSORS ON**.

Reset Your Fire Sensor

Press **2** for two seconds then enter your user code.

Lockdown

Activate a lockdown to immediately lock all public doors connected to your system. Deactivate a lockdown by allowing an authorized user to perform a Sensor Reset at the keypad.

Activate a Lockdown

1. Access the User Menu.
2. Press **CMD** until **LOCKDOWN?** displays.
3. Press any select key or area to lock all public doors.

Deactivate a Lockdown

1. Access the User Menu if Sensor Reset and Lockdown Override are enabled in your profile.
2. Press **CMD** until **SENSOR RESET?** displays.
3. Press a top row select key or area. The keypad displays **SENSORS OFF** followed by **SENSORS ON**, returning all public doors back to their previous state.

Door Lock/Unlock

Lock or Unlock Your Doors

1. Access the User Menu.
2. Press **CMD** until **DOOR LOCK/UNLOCK?** displays.
3. Press a top row select key or area. Enter the door number and press **CMD** or select **LIST** to browse doors.
4. Press the select key or area over the desired option.

Door Access

Door access is granted when an authorized credential is presented to a door access reader. The door momentarily unlocks, allowing the user to enter, then re-locks.

Enable Door Access:

1. Access the User Menu.
2. Press **CMD** until **DOOR ACCESS?** displays.
3. Press any select key or area to allow momentary access.

Armed Areas

Use this function to list your system's areas that are currently armed.

Display Armed Areas

1. Access the User Menu.
2. Press **CMD** until **ARMED AREAS?** displays.
3. Press any select key or area. Press **CMD** to advance through the list of armed areas.

Outputs On/Off

Use this function to individually turn your system's outputs on and off. Your system may use outputs to control door access, interior and exterior lighting, heating, air conditioning, and other appliances.

Turn Outputs On and Off

1. Access the User Menu.
2. Press **CMD** until **OUTPUTS ON/OFF** displays.
3. Press any select key or area.
4. Enter the output number, then select **ON** or **OFF**.

Favorites

Favorites are preset combinations that allow you to quickly activate multiple Z-Wave devices at once. You can create a Favorite that turns down your thermostat, turns off your lights, and locks your front door when you leave the building. You can add up to 25 devices to a Favorite.

Begin Here

1. Access the User Menu.
2. Press **CMD** until **ZWAVE SETUP?** displays.
3. Press any select key or area. The keypad displays **ADD LIST REMOVE**. Press **CMD** to display **FAV XFER OPT**.
4. Select **FAV**. At **FAVORITE NUMBER:**, enter a number between 1 and 20 and press **CMD**. **ADD EDIT REMOVE** display.

Add Devices to a Favorite

1. Select **ADD**.
2. Press **CMD** to browse your Z-Wave devices.
3. Press any select key or area to assign a device to a Favorite.

Edit Devices in a Favorite

1. Select **EDIT**.
2. Press **CMD** to browse your Z-Wave devices.
3. Press any select key or area to view a device's settings. Refer to the Lights, Doors, and Thermostat sections on this page to edit your devices.

Lights

Press the select key or area for the desired setting when **SETTING: ON OFF DIM** displays.

- Select **ON** or **OFF** to turn a device on or off.
- Select **DIM**, enter the dim level (1-10) of the device, and press **CMD**.

Doors

- Doors: Press the select key or area for the desired setting when **SETTING: LOCK UNLOCK** displays
- Garage Doors: Press the select key or area for the desired setting when **SETTING: OPEN CLOSE** displays.

Thermostats

Press the select key or area for the desired setting when **SETTING: OFF CL HT** displays.

Off

1. Select **OFF** to display **FAN SETTING:**
2. Press any select key or area. When **ON AUTO** displays, press the select key for the desired option.

Cool

1. Select **CL** and press any select key or area.
2. Enter the new temperature and press **CMD**.

Heat

1. Select **HT** then press any select key or area.
2. Enter the new temperature and press **CMD**.

Remove Devices in a Favorite

1. Select **REMOVE** then press **CMD** to view your devices.
2. When the desired device displays, press any select key or area to remove that device.
3. Select **YES** when **REMOVE DEVICE FROM FAV? NO YES** displays.

Z-Wave Setup

Z-Wave technology adds home automation to your system. Using Z-Wave, you can control lights, locks, small appliances, and thermostats from your keypad, Virtual Keypad App, or VirtualKeypad.com. You can add up to 140 Z-Wave devices to your system.

Begin Here

1. Access the User Menu.
2. Press **CMD** until **ZWAVE SETUP?** displays.
3. Press any select key or area. The keypad displays **ADD LIST REMOVE**. Press **CMD** to display **FAV XFER OPT**.

Add a Z-Wave Device

1. Select **ADD**.
2. Press the button on the Z-Wave device when **PRESS BUTTON ON DEVICE TO ADD** displays on the keypad.
3. Press **CMD** when **DEVICE FOUND** displays.
4. Press any top row select key or area and name the device.
5. Press **CMD** to save the device.

List Z-Wave Devices

1. Select **LIST** and **DEVICE LIST** displays.
2. Press **CMD** to advance through the list of Z-Wave devices.
3. Press any select key or area to display **DEVICE RENAME STATUS**.
4. Select **RENAME** and name the device then press **CMD**.

Remove a Z-Wave Device

1. Select **REMOVE**.
2. Press the button on the Z-Wave device when **PRESS BUTTON ON DEVICE TO REMOVE** displays on the keypad.

Status of a Z-Wave Device

1. Select **LIST** and **DEVICE LIST** displays.
2. Press **CMD** to advance through the list of Z-Wave devices.
3. Press any select key or area to display **DEVICE RENAME STATUS**.
4. Select **STATUS**. The device name and **OKAY** display when the device communicates. The device name and **FAILED** display if the device stored in the system does not communicate.
5. Press **CMD** and **REMOVE FAILED DEVICE** displays.
6. Select **YES** to remove the failed device from your system. Select **NO** to leave the device in your system.

Transfer Controller Operation

Use this function to transfer and replace your existing Z-Wave device information with information from another system.

1. Select **XFER**. The keypad warns you that transferring Z-Wave device information deletes all your Z-Wave devices connected to your system.
2. Select **YES** to proceed.
3. Initiate the transfer at the other manufacturer's Z-Wave portable controller. **ZWAVE SETUP?** displays.

Optimize Z- devices

Select **OPT**. The keypad displays **OPTIMIZE SUCCESS** when communication with a Z-Wave device is established.

Wi-Fi Setup

Use this function if your system is connected through Wi-Fi.

Begin Here

1. Access the User Menu.
2. Press **CMD** until **WIFI SETUP?** displays.
3. Press any select key or area and the keypad displays **WPS LIST MANUAL**. Press **CMD** to display **TEST**.

Use WPS to Connect Your System

1. Press the WPS button on your Wi-Fi router.
2. Select **WPS** on your keypad and **SEARCHING** displays.
3. When WPS is successful, **CONNECTED** displays on your keypad. If WPS was not successful, **WPS FAILED RETRY? NO YES** displays.
4. Press **YES** to retry. Press **NO** and **WPS LIST MANUAL** displays.

List the Available Networks

1. Select **LIST** and **SEARCHING** displays.
2. Press **CMD** to view the available Wi-Fi networks.
3. When the desired network displays, press any select key or area to connect. **W/L KEY:******* displays.
4. If the system is unable to detect the security type, press any select key or area on the keypad and **WEP WPA NONE** displays. Select the desired security type and enter your network password. See *Type In Your Keypad*.

Manually Connect Your System

1. Select **MANUAL**.
2. Enter the name of your Wi-Fi network and press **CMD. W/L KEY:******* displays.
3. If the system is unable to detect the security type, press any select key or area on the keypad and **WEP WPA NONE** display. Select the desired security type then enter your network password. See *Type In Your Keypad*.

Test the Network Connection

Select **TEST**. When the test is successful, **CONNECTED** displays. If the test is unsuccessful, **NOT CONNECTED** displays.

Zone Status

Zone status allows you to check the status of each zone, displaying a list of armed, bypassed, and alarmed zones.

Check Zone Status

1. Access the User Menu.
2. Press **CMD** until **ZONE STATUS?** displays.
3. Press any select key or area to display **ARM BYPS ALR NBR**.
 - Select **ARM** for a list of currently armed zones.
 - Select **BYPS** for a list of currently bypassed zones.
 - Select **ALR** for a list of alarmed zones since the last system disarm.
 - Select **NBR** to find a specific zone number.
4. Select the desired option and the zones related to that option display with a zone status of **OKAY**, **BYPS**, or **BAD**.

Bypass Zones

Follow these steps to bypass a zone from the User Menu. Fire, panic, emergency, supervisory, and 24-hour zones cannot be bypassed.

1. Access the User Menu.
2. Press **CMD** until **BYPASS ZONES?** displays.
3. Press any select key or area. The keypad displays **ZONE: - RST BYPS**.
4. To bypass a zone, enter the zone number and select **BYPS**. The zone number automatically disappears and a new zone number can be entered. Refer back to step 3. Confirmation will be given when the zone has been bypassed.
5. To reset a zone, enter the zone number and select **RST**. Confirmation will be given when the zone is reset.

Zone Monitor

If a door or window is opened when the system is disarmed, the keypad sounds a chime and displays the zone on the keypad.

Activate/Deactivate Chime

On a graphic touch keypad, select **Chime** in the carousel menu. On an LCD keypad, press and hold **5**.

Activate Zone Monitor

1. Access the User Menu.
2. Press **CMD** until **ZONE MONITOR?** displays.
3. Press any select key or area and the keypad displays **ALL NBR** or **PERIM ALL NBR**. Select the desired option.
 - Select **ALL** to add or remove devices from zone monitor.
 - Select **NBR** to enter a specific zone number.
 - Select **PERIM** to monitor all Night and Exit zones.

System Status

This option allows you to check the current status of your system.

Check Your System's Status

1. Access the User Menu.
2. Press **CMD** until **SYSTEM STATUS?** displays.
3. Press any select key or area. Press **CMD** to advance through the system status list. If **TRBL** displays, call your service department for assistance.

System Test

Test Your System

1. Access the User Menu.
2. Press **CMD** until **SYSTEM TEST?** displays and press any select key or area.
3. At **SYSTEM ZONES**, select **SYSTEM**. The system test automatically begins.

Test Your Zones

Burglary Zones

1. Select **ZONES**. The keypad displays **BURG**.
2. Select **BURG** and manually trip each burglary zone.
3. Select **END** to stop the test. **BURG TEST OKAY** displays when the test is complete and all zones tested okay.

Panic Zones (XR550N & XR550E only)

1. Select **ZONES**. The keypad displays **BURG PANICS**.
2. Select **PANICS** and the manually trip each burglary zone.
3. Select **END** to stop the test. **PANIC TEST OKAY** displays when the test is complete and all zones tested okay.

User Profiles

Profiles define the authorities for each user code in the system. Each user can be assigned up to four profiles. Ensure at least one administrator on your system has a profile assigned with all authorities and all areas.

User Profile Options Table

Use the User Profile Options table below to familiarize yourself on how to create a user profile.

User Profile Options	
Profile Number	Assign each profile a specific number from 1-99.
Profile Name	Assign each profile a name.
Arm/Disarm Areas	Assign each profile specific areas to arm and disarm.
Access Areas	Assign each profile door access assignments.
Output Group	Assign each profile an output group number from 1-10.
User Menu Assignments	Assign each profile specific authorities. See the User Profiles Chart.

Predefined User Profiles Table

The Predefined User Profiles table offers predefined profiles, making it easier for you to create profiles for your users. Each profile can be tailored to your specific needs. Navigate to the *Appendix* for descriptions of each user authority.

PREDEFINED USER PROFILES

AUTHORITY	MENU DISPLAY	PREDEFINED PROFILE NUMBER												
		1	2	3	4	5	6	7	8	9	10	11-98	99	
Arm/Disarm	ARM/DISARM	-	-	-	-	-	-	-	-	-	-	-	-	All
Alarm Silence	ALM SLNC	N	Y	Y	Y	Y	Y	Y	Y	Y	Y	N	N	Y
Sensor Reset	SNSR RST	Y	Y	Y	Y	Y	Y	Y	Y	Y	Y	N	N	Y
Lockdown	LOCKDOWN	Y	Y	Y	Y	Y	Y	Y	Y	Y	Y	Y	N	Y
Door Lock/Unlock	DR UNLOCK	Y	Y	Y	Y	Y	Y	Y	Y	Y	Y	Y	N	Y
Door Access	DOOR ACS	Y	Y	Y	Y	Y	Y	Y	Y	Y	Y	Y	Y	Y
Armed Areas	ARM AREA	Y	Y	Y	Y	Y	Y	Y	Y	Y	Y	N	N	Y
Outputs On/Off	OUTPUTS	N	N	N	N	Y	Y	Y	Y	Y	Y	N	N	Y
Zone Status	ZN STATS	Y	Y	Y	Y	Y	Y	Y	Y	Y	Y	N	N	Y
Bypass Zones	BYPAS ZN	N	N	N	N	N	N	Y	Y	Y	Y	N	N	Y
Zone Monitor	ZONE MON	N	N	N	Y	Y	Y	Y	Y	Y	Y	N	N	Y
System Status	SYS STAT	Y	Y	Y	Y	Y	Y	Y	Y	Y	Y	N	N	Y
System Test	SYS TEST	N	N	N	Y	Y	Y	Y	Y	Y	Y	N	N	Y
User Profiles	PROFILES	N	N	N	N	N	N	N	N	N	Y	N	N	Y
User Codes	USR CODE	N	N	N	N	N	N	N	N	N	Y	N	N	Y
Extend Schedules	EXTEND	N	N	N	N	N	N	Y	Y	Y	Y	N	N	Y
Schedules	SCHEDULS	N	N	N	N	N	N	N	Y	Y	Y	N	N	Y
Time	TIME	N	N	N	N	N	N	N	N	Y	Y	N	N	Y

AUTHORITY	MENU DISPLAY	PREDEFINED PROFILE NUMBER												
		1	2	3	4	5	6	7	8	9	10	11-98	99	
Display Events	DIS EVNT	Y	Y	Y	Y	Y	Y	Y	Y	Y	Y	N	N	Y
Service Request	SERV REQ	N	N	N	N	N	N	N	N	Y	Y	N	N	Y
Fire Drill	FIRE DRIL	N	N	N	N	N	N	N	N	Y	Y	N	N	Y
Temporary User Code	TEMP CODE	N	N	N	N	N	N	N	N	N	N	N	N	N
Anti-Passback	ANTI PASS	N	N	N	N	N	N	N	N	N	N	N	N	N
Access Time	ACCESS SCHEDULES	-	-	-	-	-	-	-	-	-	-	-	-	-
Re-Arm Delay	RE ARM DELAY (0-720)	N	N	N	N	N	N	N	Y	Y	Y	N	N	Y
Easy Arm/Disarm	EASY ARM/DISARM	N	N	N	N	N	N	N	N	N	N	N	N	N
Preferred Language	SEC LANGUAGE	N	N	N	N	N	N	N	N	N	N	N	N	N
Card Plus Pin	CARD PLUS PIN	N	N	N	N	N	N	N	N	N	N	N	N	N
Wi-Fi Setup	WIFI SETUP	N	N	N	N	N	N	N	N	N	Y	N	N	Y
Technician User	TECHNICIAN USER	N	N	N	N	N	N	N	N	N	N	N	N	N
Inactive User Audit Days	INACTIVE USER AUDIT	-	-	-	-	-	-	-	-	-	-	-	-	-
Lockdown Override	LOCKDOWN OVERRIDE	-	-	-	-	-	-	-	-	-	-	-	-	-
Dual Authority	DUAL AUTHORITY	Y	Y	Y	Y	Y	Y	Y	Y	Y	Y	Y	Y	Y
Private Door	PRIVATE DOOR	-	-	-	-	-	-	-	-	-	-	-	-	-

Begin Here

1. Access the User Menu.
2. Press **CMD** until **USER PROFILES?** displays.
3. Press any select key or area. The keypad displays **ADD DEL CHG**.

Add a User Profile

1. Select **ADD**.
2. Enter an unused **PROFILE NO:** and press **CMD**.
3. Press any select key or area and enter a **PROFILE NAME**, then press **CMD**.
4. At **ARM/DIS AREAS:**, select the area numbers the user can arm and disarm and press **CMD**.
5. At **ACCESS AREAS:**, select the area numbers the user can access and press **CMD**.
6. At **OUTPUT GROUP:**, enter the number for the Output Group assigned to this profile and press **CMD**.
7. The keypad displays each menu option that is shown in the Predefined User Profiles table. Select **YES** (fourth select key or area) or **NO** (third select key or area) for each menu option, then press **CMD** to advance through the menu options. The keypad displays **PROFILE ## ADDED** when the user profile has been successfully added.

Delete a User Profile

1. Select **DEL**.
2. Enter a **PROFILE NO:** and press **CMD**. The keypad displays **PROFILE DELTD** when a user profile is successfully deleted.

Change a User Profile

1. Select **CHG**.
2. Enter a **PROFILE NO:**, and press **CMD** twice. The keypad displays each menu option that is shown in the Predefined User Profiles table. Select **YES** or **NO** for each menu item, then press **CMD** to advance through the menu options. The keypad displays **PROFILE CHNGD** when the profile is successfully changed.

User Codes

XR Series panels support a three to six digit code that allows you to do several things from the keypad, Virtual Keypad App, or VirtualKeypad.com. Every user in the system should be assigned a user code. A user code is made up of the following elements: User Number, User Code, User Name, and Authority Level.

Begin Here

1. Access the User Menu.
2. Press **CMD** until **USER CODES?** displays. Press any select key or area. The keypad displays **ADD DEL CHG BAT**. Press **CMD** to display **FRGV SEND**.

Add a User Code

1. Select **ADD**.
2. Enter a **USER NUMBER** and press **CMD**.
3. When **ACTIVE?** displays, select **YES** to make the user code active, or select **NO** to make the user code inactive. Press **CMD**.
4. When **TEMP CODE?** displays, select **YES** to make the temporary code active, or select **NO** to make it inactive. If **YES** is selected, you will be prompted to enter a start date and an expiration date for the temporary user code.
5. Enter a **USER CODE** and press **CMD**. If you are using an access card, present the card to the reader instead of entering a code.
6. Press a top row select key or area and enter a **USER NAME**. Press **CMD**.
7. Enter a **PROFILE NO.:**, and press **CMD**. The keypad displays **USER # ADDED** when the user code has been successfully added.

Change a User Code

1. Select **CHG**.
2. Enter the current **USER NUMBER** and press **CMD**.
3. When **ACTIVE?** displays, select **YES** to make the user code active, or select **NO** to make the user code inactive. Press **CMD**.
4. When **TEMP CODE?** displays, select **YES** to make the temporary code active, or select **NO** to make it inactive. If **YES** is selected, you will be prompted to enter a start date and an expiration date for the temporary user code.

5. Press any select key or area and enter the new **USER CODE**. Press **CMD**.
6. Press any select key or area to clear the displayed name and enter a new name, if desired. Press **CMD**. See *Type In your Keypad*.
7. Enter a **PROFILE NO:** and press **CMD**. The keypad displays **USER # CHNGD** when the user code is successfully changed.

Delete a User Code

1. Select **DEL**.
2. Enter the **USER NUMBER** you want to delete and press **CMD**. The keypad displays **USER # DELTD** when the user code is successfully deleted.

Forgive Failure to Exit

Failure to exit is a violation that occurs when a user has attempted to re-enter an area that he or she did not exit through, primarily used in access control systems. Forgive failure to exit removes this violation and allows the user to re-enter the area.

1. Select **FRGV** and press **CMD**.
2. Enter the **USER NUMBER** to be forgiven and press **CMD**. The keypad displays **USER FORGVN**.

Send User Codes to Z-Wave Locks

At the **USER CODE IN LOCK? NO** display, choose whether or not the user code is stored in all compatible Z-Wave Doors. Press the third top row Select Key or Area for **NO** or the fourth top row Select Key or Area for **YES**. Then, press **CMD**.



Note: This option is only available for user codes 2-20. Once the user code has been received by the lock, entering it at the lock will lock the door or unlock the door and disarm the system depending on the user's privileges.

Ambush Code

If your system was programmed to allow user number 1 to be used as an Ambush code and when this code is entered at the keypad, a silent alarm is sent to your monitoring station. This silent alarm alerts the operator to a duress situation at the premises and prompts immediate notification of authorities.

Schedules

Schedules allow you to set recurring times when your system arms or disarms. You can also set schedules for when you want your Z-Wave devices to turn on and off.

Begin Here

1. Access the User Menu.
2. Press **CMD** until **SCHEDULES?** displays. Press any select key or area.
3. At **ALL TEMP**, select **ALL** to add, change, or delete a schedule. Select **TEMP** to add a temporary schedule. The keypad displays **TIMES AREAS DOORS**. Press **CMD** to display **OUTPUT HOLIDAYS**. Press **CMD** to display **FAVORITES**.

Add a Schedule

1. Select **TIMES**. The keypad displays **ADD DEL CHG**.
2. Select **ADD**.
3. Enter the new **SCHEDULE NUMBER** (1-99) and press **CMD**.
4. Press a top row select key or area and enter a **SCHEDULE NAME**. Press **CMD**.
5. Select the day you want to add a schedule to. Press **CMD** to display **THU FRI SAT HOL**.
6. At **ENTER BEGIN TIME -:**, enter the opening time and select **AM** or **PM**. Enter all times using a 12-hour clock.
7. At **ENTER END TIME -:**, enter the end time and select **AM** or **PM**.

Delete a Schedule

1. Select **TIMES**, then select **DELETE**.
2. Enter the schedule number (1-99) and press **CMD**.
3. At **DELETE SCHEDULE SURE? YES NO**, select **YES**.

Change a Schedule

1. Select **TIMES**, then select **CHG**.
2. Enter the **SCHEDULE NUMBER** that's changing and press **CMD**.

3. The keypad displays **ENTER SCHEDULE** and the schedule name. Press any select key or area to change the schedule name and press **CMD**.
4. Select the day you want the schedule to begin. Press **CMD** to display to display **THU FRI SAT HOL**.
5. At **ENTER BEGIN TIME -:**, enter the opening time and select **AM** or **PM**. Enter all times using a 12-hour clock.
6. At **ENTER END TIME -:**, enter the end time and select **AM** or **PM**.

Add Area, Door, and Output Schedules

1. Select either **AREAS**, **DOOR**, or **OUTPUT**.
2. At **ENTER area/door/output NUMBER:-**, enter the number you want to assign that schedule and press **CMD**.
3. At **SCHEDULE NO:-**, press any select key or area and enter the number. Press **CMD**.

Add a Holiday Schedule

Adding Holiday Dates provide the system with dates in the year when the normal opening and closing schedules are not used and replaced by one of the Holiday Schedules A or B or C. Up to forty different holiday dates can be entered. For holidays that fall on a different date each year, be sure to update their programmed Holiday Dates annually.

1. In the User Menu, select **Schedules**.
2. Select **ALL**.
3. Press **CMD** to through the different schedule options and select **HOLIDAY**.
4. At **HOL:**, press the fourth select key or area to select **HOL A**, **HOL B** or **HOL C**.
5. Press the two digit month and two digit day to enter the correct date.
6. Press **CMD** to advance through your list of holidays.

Activate a Favorite Schedule

1. Select **FAVORITES**.
2. Press any select key or area.
3. Enter a **FAVORITE NUMBER** or select **LIST** to browse the list of existing favorite numbers.
4. Press **CMD** when the desired favorite number displays. The keypad displays **FAVORITE ACTIVATED** when a Favorites schedule is successfully activated.

Add a Temporary Schedule

1. Select **TEMP**.
2. Select the type of temporary schedule you are creating: area, door, output, or favorite. (Press **CMD** to display **FAVORITE**)

Area or Door

At **NUM: ALL NONE**, enter a specific area or door number. Select **ALL** to create a schedule for all areas or doors.

Output or Favorite

At **NUM: LIST**, enter a specific output or favorites number, or select **LIST** to view a list of available areas or doors.

3. After selecting an option from above, select the day you want the schedule to begin. Press **CMD** to display to display **THU FRI SAT HOL**.
4. At **ENTER BEGIN TIME -:**, enter the opening time and select **AM** or **PM**. Enter all times using a 12 hour clock. Press **CMD**.
5. At **ENTER END TIME -:**, enter the end time and select **AM** or **PM**, and press **CMD**.
6. At **ENTER START DATE**, enter the month and day you want the schedule to start on and press **CMD**.
7. At **ENTER END DATE**, enter the month and day you want to the schedule to end on and press **CMD**.
8. Press **CMD** to save the temporary schedule.

Time

Adjust the Time and Date on Your Keypad

1. Access the User Menu.
2. Press **CMD** until **TIME?** displays. Press any select key or area.
3. The keypad displays the current day and time. Press **CMD**.
4. The keypad displays the current date. Press **CMD**.
5. At **TIME DAY DATE**, select **TIME** to change the time. The keypad displays **:- AM PM**. Enter the current time and select **AM** or **PM**. Enter the time using a 12-hour clock. Press **CMD**.
6. Select **DAY** to change the day of the week. Press **CMD**.
7. Select **DATE** to change the date. Press **CMD**.
8. At **MONTH:-**, enter up to 2 digits for the month and press **CMD**.
9. At **DAY:-**, enter up to 2 digits for the day and press **CMD**.
10. At **YEAR:-**, enter up to 2 digits for the year and press **CMD**.

Display Events

The system memory holds a maximum of 12,000 events that occurred over the last 45 days. Events older than 45 days are automatically deleted. If an action denied event has occurred

View Invalid Code Reporting with EasyEnroll™

1. Access the User Menu.
2. Press **CMD** until **DISPLAY EVENTS?** displays.
3. Press any select key. The keypad displays **DISPLAY EVENTS? FRST LST SRT**.
 - **FRST:** View the oldest to newest events.
 - **LST:** View the newest to oldest events.
 - **SRT:** Sort through the events log.

4. The keypad displays the user code connected to that event and displays **ADD CODE? NO YES**.
5. Select **YES** and the keypad displays **USER CODES?** Select **NO** to exit the User Menu.
6. Enter an available user number or press the fourth select key or area to automatically assign a user number. Press **CMD**.
7. Press any top row select key or area to clear the default name and enter a new name.
8. Enter a **PROFILE NO.:** The keypad displays **USER ADDED**.

Service Request

At **SERVICE REQUEST?**, press any select key or area. When **REQUEST MADE** displays, the request was successful.

Fire Drill

Fire Drill tests your system's bells and sirens, and does not send a message to your monitoring station.

Start a Fire Drill Test

1. Access the User Menu.
2. Press **CMD** until **FIRE DRILL?** displays, then press any select key or area.
3. Select **YES** to start the test. Enter your user code and press **CMD** to end the test.

APPENDIX

USER AUTHORITY DESCRIPTIONS

AUTHORITY	DESCRIPTION
Alarm Silence	These authorities are described in the <i>User Menu</i> section.
Sensor Reset	
Lockdown	
Door Lock/Unlock	
Door Access	
Armed Areas	
Outputs ON/OFF	
Zone Status	
Bypass Zones	
Zone Monitor	
System Status	
System Test	
User Profiles	
User Codes	
Extend Schedules	
Schedules	
Time	
Display Events	
Service Request	
Fire Drill	

USER AUTHORITY DESCRIPTIONS

AUTHORITY	DESCRIPTION
Temp User Code	Apply an expiration date and time to a user code.
Anti-Passback	Properly exit an area that was previously accessed.
Access Time	Assign up to eight schedules of door access to a profile.
Re-Arm Delay	Delay automatic re-arming when the user disarms an area outside of a schedule.
Easy Arm/Disarm	Automatically arms or disarms areas assigned to your code and re-arms the system in 60 minutes if it is outside of the scheduled disarm time.
Secondary Language	Apply a secondary language to a user's credentials.
Card Plus Pin	Access control feature that requires a card read and PIN entry for arming/disarming and access for all areas.
Wi-Fi Setup	Add, remove, or test Wi-Fi on your system.
Technician User	Cannot disarm a system that has been armed by a standard user. If the system is armed by a Test User, that person can disarm it. This is used for test purposes only.
Inactive User Audit	This option allows you to choose the number of days a user code can remain unused before the panel sends an Inactive User Code message to the receiver and changes the user code to inactive. The range is 0-425 days. The default is 0 (zero). This feature is only available for XR550 panels.
Dual Authority	Dual Authority requires two user codes to be entered at a system keypad to disarm and/or arm a specific area. Dual Authority must be enabled in Area Information programming by an installer to use this feature. Selecting DIS (Disarm) also enables Dual Authority for Access Control. When a user presents a user code to a keypad requesting to disarm or arm this area, 2ND CODE displays and requires the entry of a different user code with at least the same authority. The second user code must be entered within 30 seconds.

ADD A USER CODE

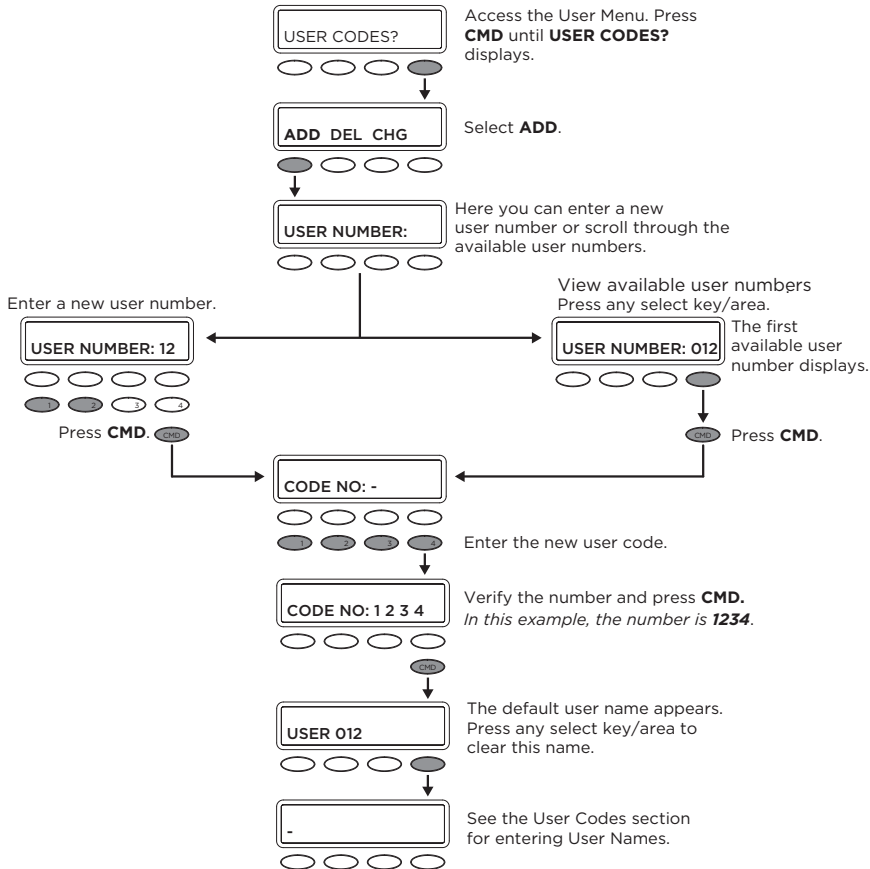

CHANGE A USER CODE

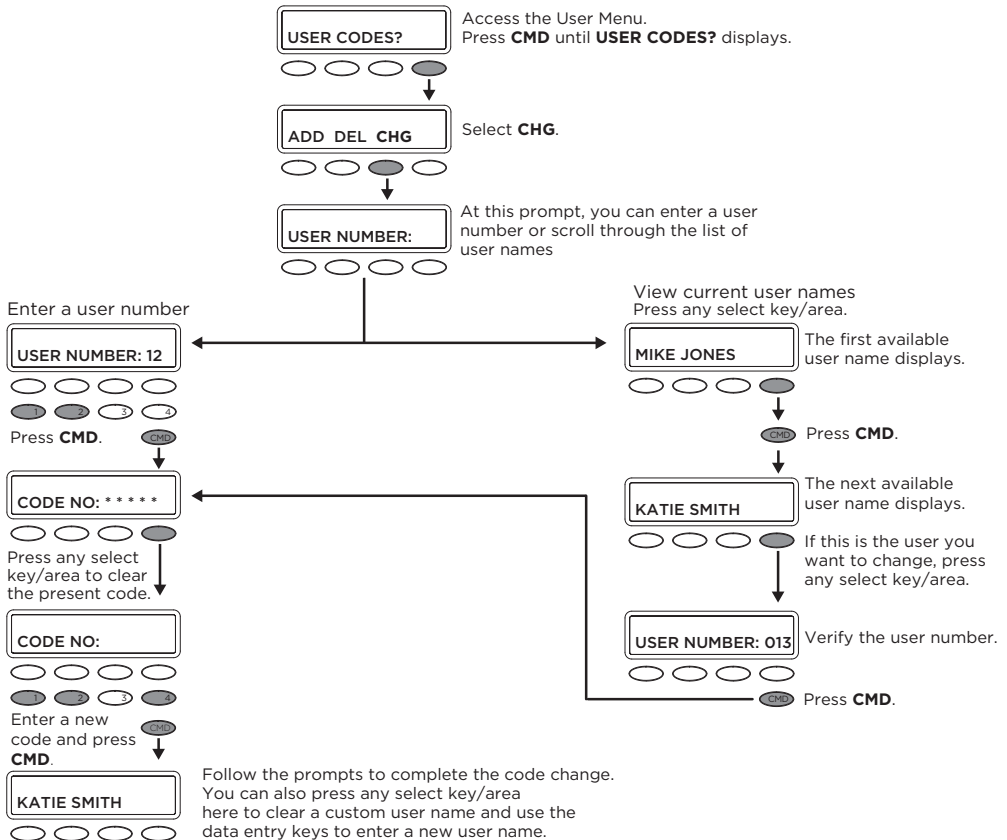

COMMON KEYPAD DISPLAYS

DISPLAY	DESCRIPTION
LOBAT	The battery in a transmitter is low.
MISNG	Periodic reports from wireless transmitters are not being received by the panel.
WIRELESS TRBL	A device in your wireless system is not working correctly.
WIRELESS RECEIVER JAMMED TRBL	Your wireless receiver has detected a jamming signal while disarmed.
WIRELESS RECEIVER JAMMED ALARM	Your wireless receiver has detected a jamming signal while armed.
ALARM	A burglary zone has been tripped.
TRBL	There is a problem with a protection device or other system component.
ALARM NOT SENT	The alarm was aborted and a message was not sent to your monitoring station.
ALARM CANCELED	The alarm message sent to your monitoring station was aborted.
ALARM VERIFIED	A valid burglar alarm was manually verified by the user.
ENTER CODE OR PRESENT CARD	The system requires a user code or credential.
TRY AGAIN	The system does not recognize the user code, card, or pin or is not authorized for that user.
INVALID CODE	The code is not recognized.
INVALID PROFILE	Attempted function that a user is not assigned.

COMMON KEYPAD DISPLAYS

DISPLAY	DESCRIPTION
INVALID AREA	Attempted door access to an area that a user is not assigned.
INVALID TIME	Attempted access by a user outside of an assigned schedule.
FAILED TO EXIT	A user has attempted to re-enter an area that they did not exit properly.
SYSTEM TROUBLE	There is a problem with one or more of your system components.
SYSTEM BUSY	Your system is performing another task of higher priority.
TEST IN PROGRESS	Your system is currently being tested.
HOME SYSTEM ON	The perimeter is armed.
PERIMETER ON	The perimeter is armed.
ALL SYSTEM ON	All areas and perimeter are armed.
SLEEP SYSTEM ON	The perimeter and interior areas are armed, excluding the bedroom area.
HOME GUEST 1 ON	The first guest house perimeter is armed.
SLEEP GUEST 1 ON	The first guest house perimeter and interior are armed, excluding the bedroom area.
ALL GUEST 1 ON	All first guest house areas are armed.

GLOSSARY

Armed

A condition in which a system can be placed. When a system is armed, a tripped sensor will cause the panel to activate an alarm.

Card Reader

A device that reads a credential. The reader verifies the credential and grants access if authorized.

Credential

A device (access card, prox key, key fob) that allows for arming, disarming, and door access.

Disarmed

An unarmed condition in which a tripped zone will not activate an alarm.

False Alarm

An alarm signal initiated without the presence of an emergency and canceled by someone with an authorized user code. A false alarm report is sent to the emergency monitoring station.

Force Arm

An action that allows your system to arm, ignoring all faulted zones. If a faulted zone restores to normal condition, it will cause the system to report an alarm if tripped.

Hardwired Systems

All devices, sensors, and detectors in your system are connected with wire.

Monitoring Station

A remote monitoring location that receives alarms from alarmed systems. Your monitoring station informs the authorities of the emergency.

Outputs

Outputs are devices that react to a device or sensor's state.

Restored

A zone returns to its normal state.

System

A compilation of devices such as a panel, keypad, sensors, etc. that make an integrated security system.

Tripped

A device that faults during an armed state, causing an alarm.

NOTES



INTRUSION • FIRE • ACCESS • NETWORKS

DESIGNED, ENGINEERED, AND MANUFACTURED IN SPRINGFIELD, MISSOURI USING U.S. AND GLOBAL COMPONENTS.
DMP.COM | LT-1278 | 21065 | © 2024 Digital Monitoring Products, Inc.